

KÄRCHER

G 2900 X

English.... 2

Español...17

Français...33

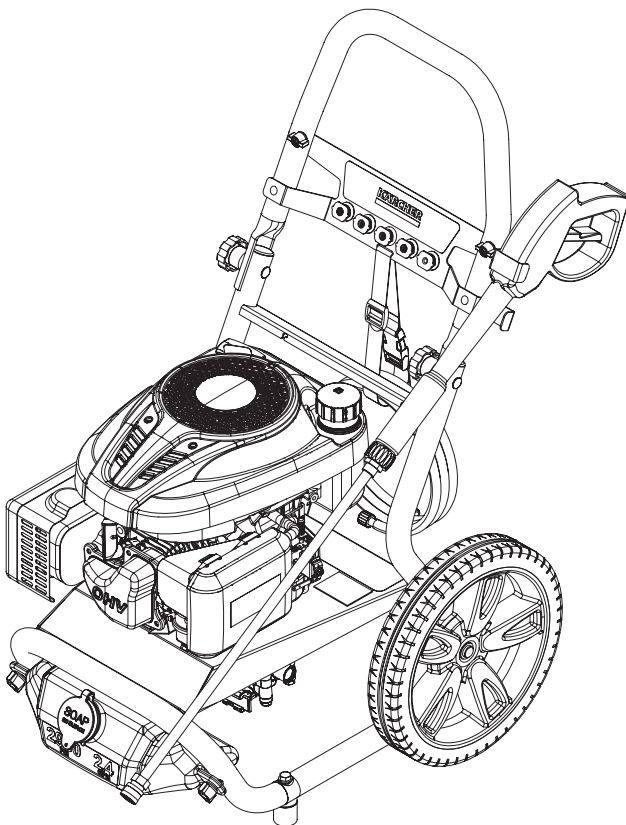

MODEL OVERVIEW

- | | | | |
|---|-------------------------|----|----------------------------------------|
| 1 | Handle | 10 | Water inlet for garden hose |
| 2 | Trigger gun | 11 | High pressure outlet |
| 3 | Trigger gun safety lock | 12 | Spark plug |
| 4 | High pressure hose | 13 | Water inlet filter |
| 5 | Spray wand | 14 | Detergent tank |
| 6 | Quick connect nozzles | 15 | Engine stop switch |
| 7 | Knob | 16 | Detergent tube connection |
| 8 | Gas Tank | | |
| 9 | Oil Dipstick | | *For engine details see engine manual. |

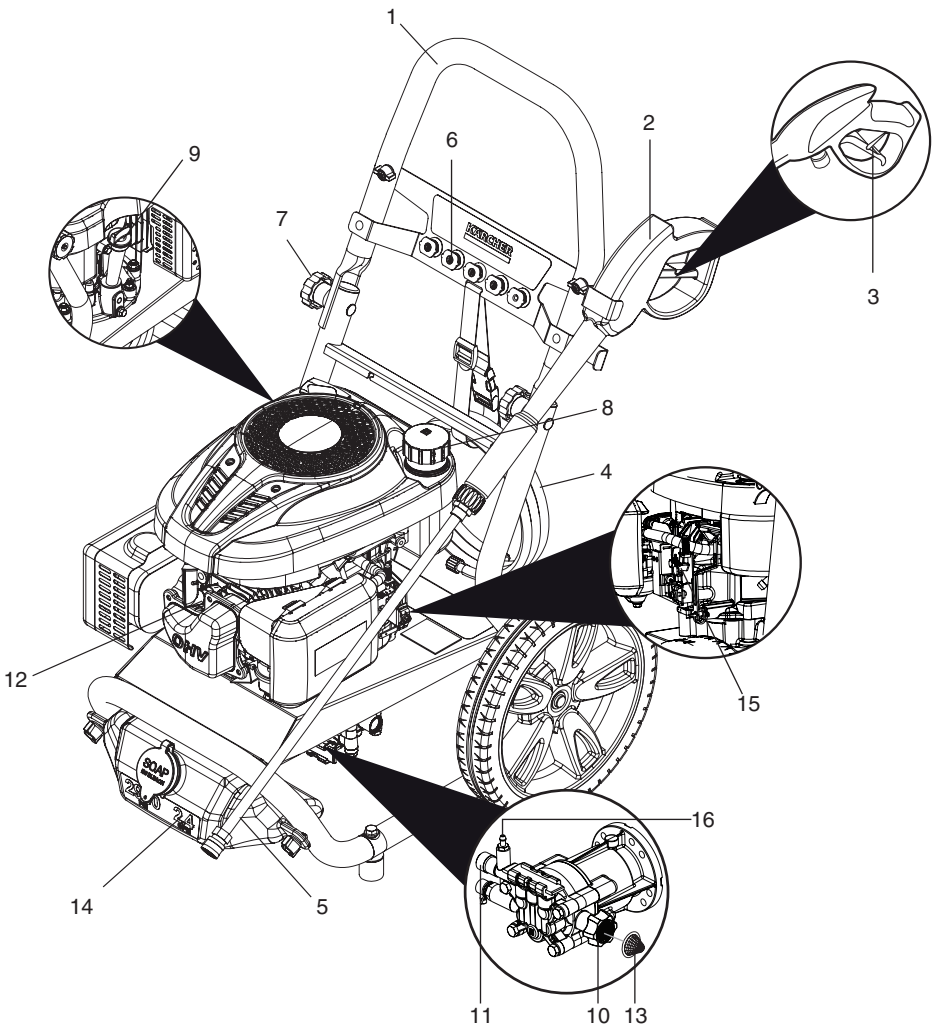

HIGH PRESSURE WASHER OPERATOR MANUAL

Model Overview	2
Important Safety Instructions	4
Assembly Instructions	6
Operating Instructions	8
Using the Accessories	9
Working With Detergents	9
Taking a Break	10
Shut down & Clean-Up	10
Winterizing and Long-Term Storage	11
Maintenance Instructions	11
Cleaning Tips	12
Troubleshooting	13
Warranty Information	15

Specifications

G 2900 X	
Operating Pressure	Max. 2900 PSI
Water Volume	Max. 2.4 GPM
Detergent Suction	0.15 - 0.20 GPM
Engine	Karcher KPS 196cc
Fuel Type	Unleaded Gas
Fuel Tank Size	0.40 gal, 1.5L
Detergent Tank	0.5 gal, 1.8L
Engine Oil Type	SAE 10W-30
Engine Oil Capacity	0.63 US qt, 0.6 L
Part No.	1.107-384.0

Safety Alert Symbols

DANGER

Indicates “an imminently hazardous situation which, if not avoided, will result in death or serious injury.”

WARNING

Indicates “a potentially hazardous situation which, if not avoided, could result in death or injury.”

CAUTION

Indicates “a potentially hazardous situation which, if not avoided, may result in minor or moderate injury or in property damage incidents.”

Owner/User Responsibility

The owner and/or user must have an understanding of the manufacturer’s operating instructions and warnings before using this pressure washer. Warning information should be emphasized and understood. If the operator is not fluent in English, the manufacturer’s instructions and warnings shall be read to and discussed with the operator in the operator’s native language by the purchaser/owner, making sure that the operator comprehends its contents. Owner and/or user must study and maintain for future reference the manufacturer’s instructions.

Kärcher Customer Support USA/ Canada



Call: **1-800-537-4129** for help or visit our website:

karcher.com/us

Please take a moment to register your pressure washer online at:

www.karcher-register.com

IMPORTANT SAFETY INSTRUCTIONS

  Read the operating instructions of the engine manufacturer before start-up and follow the safety instructions carefully.

 **WARNING**

When using this product, basic precautions should always be followed, including the following:

- Read all instructions before using product.
- To reduce the risk of injury, close supervision is necessary when a product is used near children.
- Know how to stop the product and bleed pressures quickly. Be thoroughly familiar with the controls.
- Stay alert, watch what you are doing.
- Do not operate when fatigued or under the influence of alcohol or drugs.
- Keep operating area clear of all persons.
- Do not overreach or stand on unstable support. Keep good footing and balance at all times.
- Wear safety goggles and ear protection.
- Follow the maintenance instructions specified in the manual.
- To avoid risks, all repairs and replacement of spare parts should only be carried out by trained personnel.

 **WARNING**

Risk of injection or injury, do not direct discharge stream at persons or animals.

- High pressure jets can be dangerous if misused. The jet must not be directed at persons, animals, electrical devices, or the unit itself.

 **DANGER**

Do not spray electrical connections, electrical outlets or fixtures.

 **WARNING**

Risk of explosion, do not spray flammable liquids. Operate only where open flame or torch is permitted.

- Do not use acids, solvents, or any alkaline or flammable material in this product. These products can cause physical injuries to the operator and irreversible damage to the machine.

 **WARNING**

Gun kicks back, hold with both hands.

- The trigger gun safety lock prevents the trigger from accidentally being engaged. This safety feature must be engaged when replacing nozzles or not in use.

 **CAUTION**

Risk of asphyxiation: use this product only in a well ventilated area.

- Operate and fuel machine in a well ventilated area, free of devices featuring an open pilot or flame such as boilers, water heaters, etc.

 **CAUTION**

Risk of fire, do not add fuel when the product is operating or still hot.

- Do not operate if fuel has been spilled. Instead, move machine to different location and avoid creating sparks.
- This machine has hot surfaces which can cause burns. Operate in a safe environment and away from children.
- Do not touch hot surfaces or allow accessories to contact hot surfaces.
- Do not leave machine running unattended.
- Avoid tipping machine on its side.

 **WARNING**

Serious injury can result from high pressure discharge produced by pressure washers.

Keep out of reach of children.

IMPORTANT SAFETY INSTRUCTIONS

WARNING PROP 65

This product and accessories can expose you to chemicals known to the State of California to cause cancer and birth defects or other reproductive harm. For more information about this regulation: www.P65Warnings.ca.gov
Wash hands after handling.

SAVE THESE INSTRUCTIONS

WATER SUPPLY (Cold Water Only)













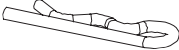
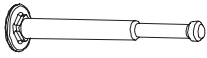

CAUTION

When connecting to water supply mains, local regulations of your municipal water company must be observed. In some areas connecting directly to public drinking water supply may require a backflow prevention device. This is to ensure that there is no feedback of chemicals into the water supply. Use a water filter to avoid potential damage from dirt in the water supply.

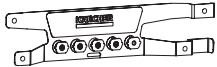
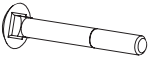
- Garden hose must be at least 5/8 inch inside diameter.
- Flow rate of water supply must not fall below 2.4 GPM (gallons per minute)
- Supply water pressure must be greater than 40 PSI.
- Flow rate can be determined by running the water for one minute into an empty 5-gallon container.
- The water supply temperature must not exceed 122°F/50°C.
- Never use the pressure washer to draw in water contaminated with solvents, e.g. paint thinners, gasoline, oil, etc.
- Always prevent debris from being drawn into the unit by using a clean water source. Use additional water filter.
- Do not operate pressure washer without the water turned on.

ASSEMBLY INSTRUCTIONS

Hardware (included)

	Description	Purpose	Illustration	Qty
A	Detergent siphon hose	Tank assembly		1
B	Tank	Tank assembly		1
C	Hexagonal 1/4" bolt	Tank assembly		2
D	Tank knob	Tank assembly		2
E	Wheel	Wheel assembly		2
F	Spacer 1/2"	Wheel assembly		2
G	Axle	Wheel assembly		2
H	Cotter pin	Wheel assembly		2
I	Carriage bolts	Handle assembly		2
J	Knob	Handle assembly		2
K	Nozzle holder	Nozzle holder assembly		1
L	1/4" carriage bolt	Nozzle holder assembly		4
M	Knob with nut	Nozzle holder assembly		4
N	Quick connect nozzle Kit	Nozzle kit assembly		1
O	Wand	Wand assembly		1
P	Spray gun	Spray gun assembly		1
Q	High pressure hose	Spray gun assembly		1

Assembling

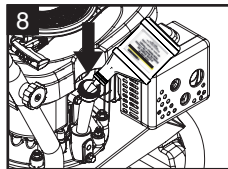
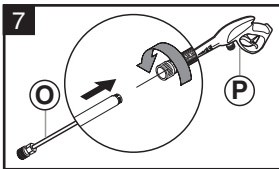
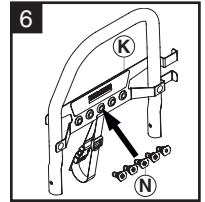
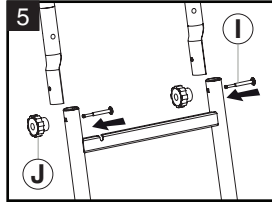
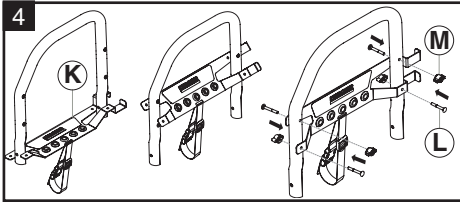
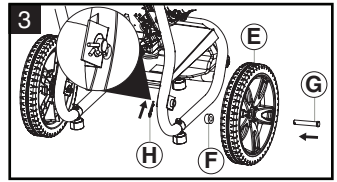
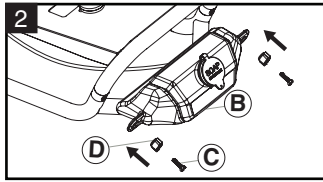
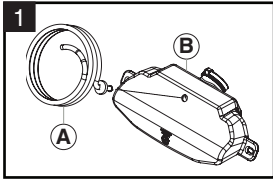

Assembling

→ Illustration 1:

Pass the detergent siphon hose (A) under the machine, aligning the detergent fill hole on the detergent tank (B) towards the front of the machine. Place detergent hose (A) into the detergent hose hole on the back of the detergent tank (B), and insert until the hose end rests on the bottom of the deepest part of the tank.

→ Illustration 2:

Insert hexagonal $\frac{1}{4}$ " bolts (C) into tank knobs (D). Insert through the flanges on the edges of the detergent tank (B), into the holes on the frame, and tighten.

→ Illustration 3:

Feed axle (G) through hub of wheel (E), and spacer $\frac{1}{2}$ " (F). Insert assembly into axle mount at back of frame. Push straight side of cotter pin (H) through hole in axle until locked in place. Repeat on other side of unit.

→ Illustration 4:

Mount nozzle holder (K) to handle as shown in illustration, align holes, insert $\frac{1}{4}$ " carriage bolts (L) and secure with knob with nut (M).

→ Illustration 5:

Attach the handle to the frame of the pressure washer. Align holes in handle with holes in lower frame, insert carriage bolts (I), and tighten with knobs (J).

→ Illustration 6:

Place the quick connect nozzles (N) in the nozzle holder (K).

→ Illustration 7:

Push the wand (O) into the spray gun (P) and then thread the connection to secure.

→ Illustration 8:

Remove the cap/dipstick from the engine and add correct amount of oil. Be sure oil level is between "FULL/MAX" and "ADD/MIN" marks on dipstick with machine on level surface. Replace cap/dipstick.

OPERATING INSTRUCTIONS

→ STEP 1:

Pull the spring-loaded collar of the wand back to insert your choice of quick connect nozzle.

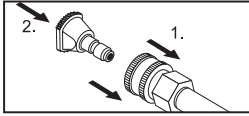

Release the collar and push the nozzle until the collar clicks.

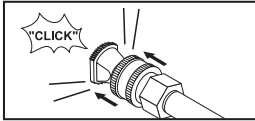

⚠ CAUTION

High pressure in nozzle area.

Risk of injury caused by improperly locked nozzle.

- Make sure you hear a "click" when inserting the nozzle tip in to the wand.
- Pull the nozzle to make sure it is seated properly before operating your unit.

→ STEP 2:

Attach the high pressure hose to the trigger gun.

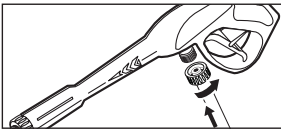

⚠ CAUTION

Engine shipped without oil. Before starting engine, fill with oil. Do not over-fill. Do not run the engine with a high or low oil level as this can cause engine damage.

If you have further questions regarding the engine, please refer to the engine manual included with the unit.

→ STEP 3:

Check oil level. Oil level should always be between the "FULL" and "ADD" or "MAX" and "MIN" marks on the dipstick as shown in the picture below.

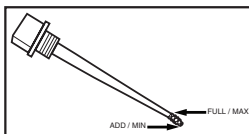

Be sure the machine is level when checking the oil level. (Refer to the engines operating manual for seasonal grades).

We recommend that the oil be changed after the first 5 hours of use, then once every 50 hours.

→ STEP 4:

Fill gas tank with unleaded gasoline.

Do not use leaded gasoline.

Do not add oil to the gasoline.

→ STEP 5:

Connect the high pressure hose to the high pressure outlet on the pump.

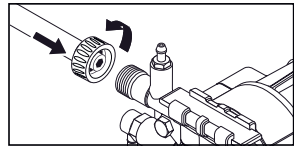

→ STEP 6:

Connect garden hose to unit's water inlet.

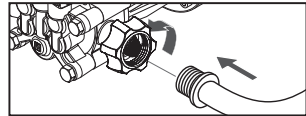

→ STEP 7:

Connect garden hose to the cold water source and turn water completely on.

Do not use hot water.

→ STEP 8:

Unlock the trigger gun safety lock. Pull trigger to eliminate trapped air, wait for a steady flow of water to emerge from the spray nozzle.

→ STEP 9:

Move the engine STOP switch to the ON position.

→ STEP 10:

Pull the starter handle. If the engine fails to start after 3 pulls, squeeze the trigger gun to release pressure, and repeat step.

For engine details see engine manual.

USING THE ACCESSORIES

Quick connect nozzles

The color-coded quick connect nozzles provide a wide array of spray widths from 0° to 65° and are easily accessible when placed in the convenient nozzle holder.

0° spray angle = Red nozzle

For particularly stubborn accumulation of grime. Not recommended for soft materials like sidings, decks, painted surfaces, cars.

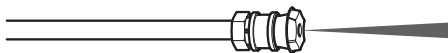

15° spray angle = Yellow nozzle

For dirt accumulation over a surface.

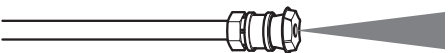

25° spray angle = Green nozzle

For dirt accumulation over a large surface.

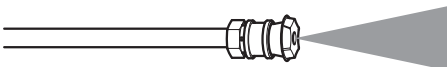

40° spray angle = White nozzle

For moderate dirt accumulation over a large surface.

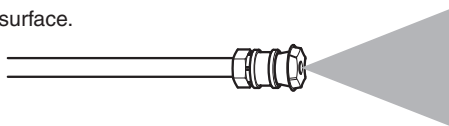

65° spray angle = Black nozzle

For operating with detergents or cleaning with low pressure.

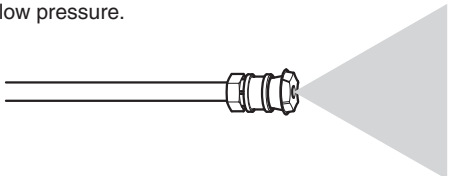

⚠ CAUTION

High pressure in nozzle area. Risk of injury caused by improperly locked nozzle.

- Make sure you hear the "click" when inserting the nozzle tip into the quick connection.
- Pull the nozzle to make sure it is seated properly before operating your unit. (See OPERATING INSTRUCTIONS: Step 1)

⚠ WARNING

To avoid serious injury never point spray nozzle at yourself, other persons or animals.

WORKING WITH DETERGENTS

Detergents can only be applied with the black detergent nozzle.

➔ STEP 1:

Install the black detergent nozzle for detergent application at low pressure.

➔ STEP 2:

Fill the tank with Kärcher detergent diluted per manufacturer's instructions.

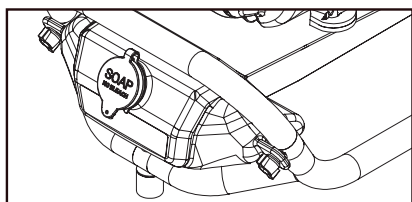

➔ STEP 3:

With the engine running, pull trigger to operate unit.

Liquid detergent is drawn into the unit and mixed with water.

Apply detergent to work area.

Do not allow detergent to dry on surface.

➔ STEP 4:

Always draw fresh water through the detergent suction tube when the cleaning job is done, to rinse/flush any remaining detergents from the injection system.

See **Cleaning Tips** for specific information on how to clean different surfaces.

WORKING WITH DETERGENTS

Detergents

CAUTION

This unit has been designed for use with cleaning detergents recommended by the manufacturer.

The use of other cleaning detergent may affect the operation of the machine and void the warranty.

Always Use Kärcher Detergent for Best Results

Kärcher biodegradable detergents are specially formulated to protect the environment and your pressure washer. The special formula won't clog the suction tube filter and will protect the internal parts of the pressure washer for a longer life. For Kärcher Detergents, check your retailer or visit our website:

karcher.com/us

CAUTION

Never use:

- Bleach, chlorine products or other corrosive chemicals
- Liquids containing solvents (i.e., paint thinners, gasoline, oils.)
- Tri-sodium phosphate products
- Ammonia products
- Acid-based products

These chemicals will harm the unit and damage the surface being cleaned.

Use of these items will void the warranty.

TAKING A BREAK ...five minutes or more

➔ STEP 1:

Move the engine stop switch to the OFF position.

➔ STEP 2:

Release trigger and engage safety lock.

SHUT DOWN & CLEAN-UP

➔ STEP 1:

If detergents have been used, remove detergent suction tube from container and insert into 1 gallon of fresh water.

Siphon water at low pressure for one minute to clear the line of residual detergent.

➔ STEP 2:

Move the engine stop switch to the OFF position.

➔ STEP 3:

Turn off the water source.

➔ STEP 4:

Press trigger to release water pressure.

➔ STEP 5:

Release trigger and engage gun safety lock.

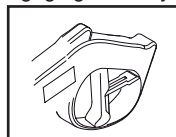

➔ STEP 6:

Disconnect the garden hose from the water inlet on the unit.

➔ STEP 7:

Disconnect the high pressure hose from the high pressure outlet. Store the high pressure hose in the hose holder assembly.

WINTERIZING AND LONG-TERM STORAGE

It is highly recommended to use Kärcher's Pump Guard (part number 9.558-998.0) before winter storage and during the cleaning season to protect the pump from freezing and premature wear.

→ STEP 1:

Move throttle to stop position.

→ STEP 2:

Disconnect all hoses.

→ STEP 3:

Unscrew cap from Pump Guard bottle.

→ STEP 4:

Remove internal seal.

→ STEP 5:

Reattach cap to Pump Guard bottle and remove black protective cap.

→ STEP 6:

Screw bottle into water inlet on pressure washer pump and squeeze.

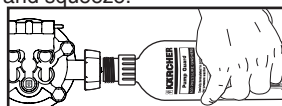

→ STEP 7:

With the engine stop switch in STOP position, pull starter handle until fluid starts to exit.

→ STEP 8:

Unscrew bottle. Store or dispose properly.

⚠ CAUTION

Failure to follow the above directions may result in damage to the pump assembly and accessories and void the warranty.

MAINTENANCE INSTRUCTIONS

Kärcher pump

Initial Use

All Kärcher pumps are factory lubricated and sealed and require no further lubrication.

Pump Inspection

You should routinely make a visual inspection of the pressure washer's pump. If you notice oil leaking around the pump seals, you should take the pressure washer to a Kärcher-Authorized Service Center for repair. (You can locate a service center in your area online at: www.karcher-service.com).

Pump Maintenance

The pump on your Kärcher pressure washer does not require maintenance. Any attempts to service or alter the pump may damage your pressure washer and void your product warranty.

Engine

Carry out maintenance tasks for the engine according to the specifications provided in the operating instructions provided by engine manufacturer.

CLEANING TIPS

Deck Cleaning

(with or without detergent). Pre-rinse deck and surrounding area with fresh water. If using Karcher Multipurpose Cleaner, apply to surface at low pressure. For best results, limit your work area to smaller sections of approximately 25 square feet. Allow Karcher Multipurpose Cleaner to remain on surface 1-3 minutes. Do not allow detergent to dry on surface. Rinse at high pressure in a long sweeping motion keeping the spray nozzle approximately 3-6 inches from the cleaning surface. Always clean from top to bottom and from left to right. When moving on to a new section of the cleaning surface, be sure to overlap the previous section to eliminate staple marks and ensure a more even cleaning result.

Cars, Boats & Motorcycles

(with or without detergent). Pre-rinse vehicle with fresh water. If using Karcher Vehicle Wash and Wax, apply to surface at low pressure. For best results, clean one side of vehicle at a time and always apply detergent from bottom to top, do not allow detergent to dry on surface. If needed, use special wash brush attachment (not included) to remove stubborn dirt. Rinse at high pressure in a sweeping motion keeping the spray nozzle approximately 6-8 inches from the cleaning surface (distance should increase when rinsing pin-stripping or other sensitive surfaces). Always clean from top to bottom and from left to right. For best results, wipe surface dry with a chamois or soft dry cloth.

House Siding

(with or without detergent). Pre-rinse cleaning surface with fresh water. If using Karcher Multipurpose Cleaner, apply to surface at low pressure (for best results, limit your work area to sections of approximately 6 feet and always apply detergent from bottom to top). Allow detergent to remain on surface 1-3 minutes. Do not allow detergent to dry on surface, if surface appears to be drying, simply wet down surface with fresh water. If needed, use special wash brush attachment (not included) to remove stubborn dirt. Rinse at high pressure from top to bottom in an even sweeping motion keeping the spray nozzle approximately 6 inches from the cleaning surface.

Cement Patios, Brick and Stone

(with or without detergent). Pre-rinse cleaning surface with fresh water. If using Karcher Multipurpose Cleaner, apply to surface at low pressure. For best results, limit your work area to smaller sections of approximately 25 square feet. Allow Karcher Multipurpose Cleaner to remain on surface 1-3 minutes. Do not allow detergent to dry on surface. Rinse at high pressure in a sweeping motion keeping the spray nozzle approximately 3- 6 inches from the cleaning surface. Always clean from top to bottom and from left to right. For removing extremely stubborn stains, use a Turbo Nozzle Spray Nozzle (sold separately).

Barbecue Grills, Outdoor Power Equipment & Gardening Tools

(with or without detergent). Pre-rinse cleaning surface with fresh water. If using Karcher Multipurpose Cleaner, apply detergent at low pressure. Allow Karcher Multipurpose Cleaner to remain on surface 1-3 minutes. Do not allow detergent to dry on surface. Rinse at high pressure keeping the spray nozzle approximately 3-6 inches from the cleaning surface. For removing extremely stubborn dirt, it may be necessary to move the spray nozzle even closer to the surface for greater dirt cutting action.

Patio & Lawn Furniture

(with or without detergent). Pre-rinse furniture and surrounding area with fresh water. If using Karcher Multipurpose Cleaner, apply to surface at low pressure. Allow Karcher Multipurpose Cleaner to remain on surface 1-3 minutes. Do not allow detergent to dry on surface. If needed use special Wash Brush Attachment (not included) to remove stubborn dirt. Rinse at high pressure in a sweeping motion keeping the spray nozzle approximately 3-6 inches from the cleaning surface. For best results, clean from top to bottom and from left to right.

CLEANING TIPS

Recommendations

- Before cleaning any surface, test spray pattern and distance in an inconspicuous area.
- If painted surfaces are peeling or chipping, use extreme caution as pressure washer may remove the loose paint from the surface.
- When using on surfaces which might come in contact with food, flush surfaces with plenty of drinking water.
- For additional cleaning tips, visit our website at karcher.com/us

Optional Accessories

Optional accessories are available to further enhance your cleaning capabilities. These accessories are accurate as of the printing date of this manual. Please check our website:

karcher.com/us for pricing and up-to-date information.

- Extension Hose
- Turbo Nozzle
- 15-Inch Surface Cleaner, 3200 PSI

TROUBLESHOOTING

CAUTION

Remove the spark plug cable to prevent accidental ignition of the engine before making any repair.

Symptom	Cause	Solution
ENGINE WILL NOT START	No gasoline	Fill gas tank
	Ignition switch ON/OFF	Turn ignition switch to the ON position
	Water pressure built up in the machine	Squeeze the trigger to release the pressure
	For additional engine problems refer to the engine manual.	
NOT ENOUGH PRESSURE	Diameter of garden hose is too small	Replace with a 5/8" inside diameter or larger garden hose
	Water supply is restricted	Check garden hose for kinks, leaks or blockage
	Not enough inlet water supply	Turn water on full force. Check garden hose for kinks, leaks or blockage.
	Water inlet filter is clogged	Remove filter and rinse out in warm water
	Black detergent nozzle is attached	Remove black detergent nozzle and attach high pressure nozzle
OUTPUT PRESSURE VARIES HIGH AND LOW	Not enough inlet water supply.	Turn water on full force. Check garden hose for kinks, leaks or blockage
	Pump is sucking air	Check that hoses and fittings are air tight. Turn off machine and purge pump by squeezing trigger gun until a steady flow of water emerges through the nozzle
	Water inlet filter is clogged	Remove filter and rinse out in warm water
	Spray nozzle is obstructed	Blow out or remove debris with a fine needle
	Calcified gun, hose or spray wand	Run distilled vinegar through detergent suction tube.

TROUBLESHOOTING

Symptom	Cause	Solution
NO DETERGENT	Detergent suction tube not properly connected to the machine	Check connection
	Detergent is too thick	Dilute detergent, for best results use Kärcher detergent
	Filter on detergent suction tube is clogged	Run warm water through filter to remove debris
	Damaged or clogged detergent suction tube	Remove obstruction or replace detergent suction tube
	A high pressure nozzle is attached	Replace with black detergent nozzle
	Spray nozzle is obstructed	Blow out or remove debris with fine needle
GARDEN HOSE CONNECTION LEAKS	Loose fittings	Tighten fittings
	Missing/worn rubber washer	Insert new washer
SPRAY WAND LEAKS	Spray wand not properly attached	Turn the swivel nut of the gun clockwise until connection is tight
	Broken o-ring or plastic insert	Visit www.karcher-help.com or locate a service center at www.karcher-service.com
PUMP IS NOISY	Not enough water supply	Check that hoses and fittings are air tight. Turn off machine and purge pump by squeezing trigger gun until a steady flow of water emerges through the nozzle
WATER LEAKS FROM PUMP (UP TO 10 DROP PER MINUTE IS PERMISSIBLE)	Loose fittings	Check fittings
	Water seals are damaged or worn.	Visit www.karcher-help.com or locate a service center at www.karcher-service.com
	Thermal protection device is activated.	Thermal protection device will auto reset. Do not run pump for more than 5 minutes without spraying
OIL DRIP	Oil seals are damaged or worn	Visit www.karcher-help.com or locate a service center at www.karcher-service.com

If the symptom you are experiencing is not listed above, or if the provided solutions do not solve your issue, please visit our extensive online troubleshooting database at:

www.karcher-help.com

High Pressure Washers

Limited warranty

KÄRCHER

This Kärcher product is warranted by Kärcher to be free of defects in workmanship and materials under normal use.

Specific warranty applies to:

- Kärcher KPS and KXS series engines are warranted for three (3) years parts and labor and serviced by a Kärcher service center
- Honda GC series engines are warranted for two (2) years parts and labor and serviced by a Honda authorized service center
- Honda GX series engines are warranted for three (3) years parts and labor and serviced by a Honda authorized service center
- Kohler RH series engines are warranted for two (2) years parts and labor and serviced by a Kohler authorized service center
- Pumps are warranted for two (2) years parts and labor and are serviced by a Kärcher service center
- Frames, handles and detergent tanks, and other structural components, carry a one (1) year parts and labor warranty.
- Standard accessories and attachments are warranted for a ninety (90) day period.
- Any commercial, industrial or rental use of this equipment will reduce the warranty to ninety (90) days.

The warranty period is calculated from the date of purchase by the end user and covers the cost for replacement parts and/or equipment and warranty labor performed. In order to verify a warranty situation, the machine must be evaluated by an Authorized Kärcher Service Center or by an authorized service center representing the engine manufacturer. A copy of the original purchase receipt or gift receipt from the original retailer must also accompany the warranty claim. To locate the nearest authorized Kärcher service center, please visit our website at www.Kärcher-service.com.

Kärcher's obligation under this warranty shall strictly be limited, at Kärcher's option, either to replace or repair, through Kärcher direct or through an Authorized Kärcher Service Dealer without charge during the warranty period any part, which in the opinion of the manufacturer, shows defect in workmanship or material. Service will be scheduled according to the normal work flow and business hours at the service center, and availability of replacement parts. All decisions of Kärcher with regard to this limited warranty shall be final.

This warranty does not cover:

- Merchandise sold as reconditioned, used, demonstration or floor models.
- Merchandise purchased on eBay and other online auction web sites.
- Damage caused by misuse, neglect, accident, abuse, improper handling, freezing, normal wear and tear or non-compliance with operator's manual.
- Damage caused by water sediment, contaminated water supply or use of chemicals and detergents not approved by or recommended by Kärcher.

WARRANTY INFORMATION

- Damage caused by acts of nature such as floods, fires, earthquakes, lightning strikes, etc.
- Devices or accessories not distributed or approved by Kärcher. Any use of such said devices or accessories will void implied warranty.
- Repairs made by the end user or any service center not authorized by Kärcher. Any such tampering with Kärcher equipment or accessories will void the implied warranty.
- Any cost for shipping by the customer or authorized service center of the alleged defective part or equipment.

This warranty is non-transferable and applies only to products purchased through a Kärcher authorized reseller in the United States and Canada. Equipment provided, but not manufactured by Kärcher such as Honda and Kohler gasoline engines are subject to warranties and service through said manufacturer's service centers according to the terms and conditions provided by the respective original equipment manufacturer. Kärcher is not authorized and has no responsibility to provide warranty service for Honda and Kohler engines. This warranty gives you specific legal rights. You may have other rights, which vary by country and state/province.

Please register online at www.karcher-register.com. Online registration is quick, free and provides you with a confirmation email for your records.

If you do not have internet access, please return the warranty registration card included in the accessory bag. It is not necessary to use an envelope. Please remember to use a first-class postage stamp. The Postal service will not deliver without a stamp.